

SINADRIVES®
DIRECT DRIVE EXPERTS

Accessories

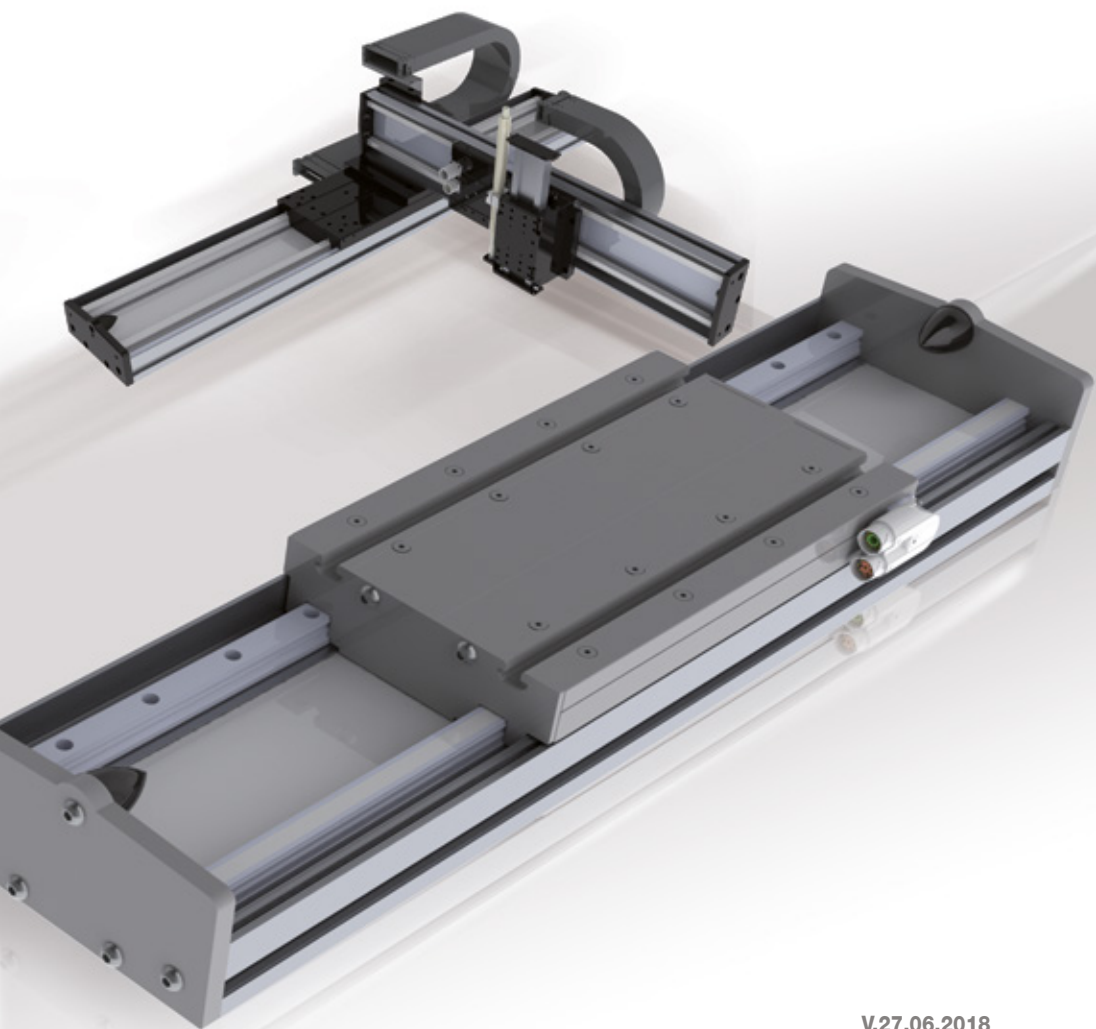

V.27.06.2018

Serie:

MLE/ MLU/ MLZ

MLL/ MLLZ/ MCE

Table of Contents

- 1. Limit switch**
- 2. Power cable**
- 3. Encoder cable**
- 4. Central lubrication**
- 5. Mounting Block**
- 6. Mounting Set**
- 7. Nuts**

SINADRIVES

Unsöldstrasse 2, 80538 Munich, Germany
Tel. +49 (0) 89 255 575 898 / Fax. +49 (0) 89 255 575 899
www.sinadrives.com / info@sinadrives.com

or

SINADRIVES, SAIN Automation Solutions S.L.

Avinguda Mas Pins, 164 Nave 6
17457 Riudellots de la Selva - Girona / Spain
Tel. +34 972 442 452 / Fax. +34 972 442 317
www.sinadrives.com / info@sinadrives.com

Innovation & Excellence

1. Limit switch

The limit switches have two closed contacts. On the image below, you can see the colour coding of the cable:

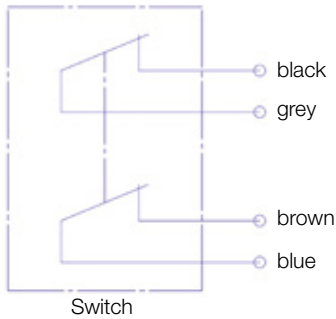

The head of the switch can turn 90, 180 or 270 degrees to reach the necessary position. To turn the head, loosen the 2 screws on the plastic housing. After positioning the head, the lever must now be adjusted to set the angle of actuation. To adjust the lever, loosen the screw on the head and bring it to the desired position.

Ensure the position is correct when mounting the limit switch.
You can see the correct and incorrect position in the following images.

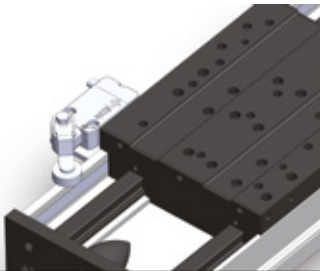

CORRECT!

The carriage cannot damage the switch.

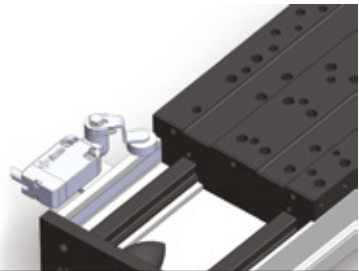

INCORRECT!

The carriage can damage the switch.

2. Power cable

Designations

	AC05	P	M	00	10
Sinadrives cable					
P: Power cable					
Connector					
M: M23					
Y: Y-TEC					
0: Free cables					
Pinout					
00: Standard					
Cable length, in meter					

Technical data:

	AC05-PMxxxx	AC05-PYxxxx
Min. bend radius (static):	39mm	39mm
Min. bend radius (dynamic):	78mm	78mm
Operating temperature:	-40 .. +80°C	-40 .. +80°C
Diameter:	12,9mm	12,9mm
Cable cross-section:	4G1,5+2x2x0,75mm ²	4G1,5+2x2x0,75mm ²
Outer material:	PUR	PUR
Resistance:	resistant to oil, hydrolysis and microbic influences (VDE 0472)	
Weight:	0,26Kg/m	0,26Kg/m
Nominal current:	16A	16A

Standard pinout:

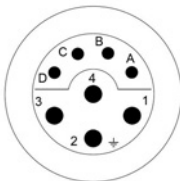

AC05-PMxxxx		
M23	Signal	Output
1	U	U/L1
4	V	V/L2
3	W	W/L3
2	PE	green/yellow
A	KTY21	7
B	KTY21	8
C	PTC+	5
D	PTC-	6

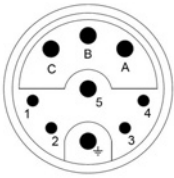

AC05-EYxxxx		
Y-TEC	Signal	Output
A	U	U/L1
B	V	U/L2
C	W	W/L3
PE	PE	green/yellow
1	KTY21	7
2	KTY21	8
3	PTC+*	5
4	PTC+*	6

* only if the signal doesn't appear on the encoder connector (either there or here).

3. Encoder Cable

Designations

	AC05	E	M	00	10
Sinadrives cable					
E: Encoder cable					
Connector					
M: M23					
Y: Y-TEC					
0: Free cables					
Pinout					
00: Standard					
Cable length, in meter					

Technical data:

	AC05-EMxxxx	AC05-EYxxxx
Min. bend radius (static):	28mm	28mm
Min. bend radius (dynamic):	56mm	56mm
Operating temperature:	-40 .. +80°C	-40 .. +80°C
Diameter:	9,2mm	9,2mm
Cable cross-section:	4x2x0,34+4x0,5mm ²	4x2x0,34+4x0,5mm ²
Outer material:	PUR	PUR
Resistance:	resistant to oil, hydrolysis and microbic influences (VDE 0472)	
Weight:	0,13Kg/m	0,13Kg/m

Standard pinout:

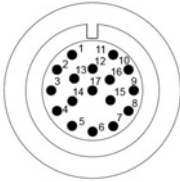

AC05-EMxxxx		
M23	Signal	Output
1	A+ (COS)	green
2	A- (COS)	yellow
3	B+ (SIN)	brown
4	B- (SIN)	black
7	GND	black/white
8	Vcc	red/white
10	RI+/DATA+	violet
11	RI-/DATA-	blue
12	CLK+	red
13	CLK-	orange
16	Vcc sensor	yellow/white
17	GND sensor	blue/white

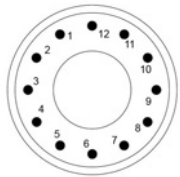

AC05-EYxxxx		
Y-TEC	Signal	Output
1	A+ (COS)	green
2	A- (COS)	yellow
3	B+ (SIN)	brown
4	B- (SIN)	black
5	RI+/DATA+	violet
6	RI-/DATA-	blue
7	Vcc	red/white
8	GND	black/white
9	PTC+	yellow/white
10	PTC-	blue/white
11	CLK+	red
12	CLK-	orange

4. Central lubrication

As an option, SINADRIVES provides a central oil lubrication system. All locations to be lubricated are connected by a 6mm hose.

This system allows all the locations to be lubricated to be reached pneumatically or manually. The electrical and pneumatic pump is not included in the delivery. We recommend using a pump with a minimum pressure of 25 bar. The best way to control the system is via PIL. The dose time should be between 20-30 seconds.

For the supply, we recommend a line with an outer diameter of 6mm and a wall thickness of 1.5mm that can withstand a minimum pressure of 25 bar.

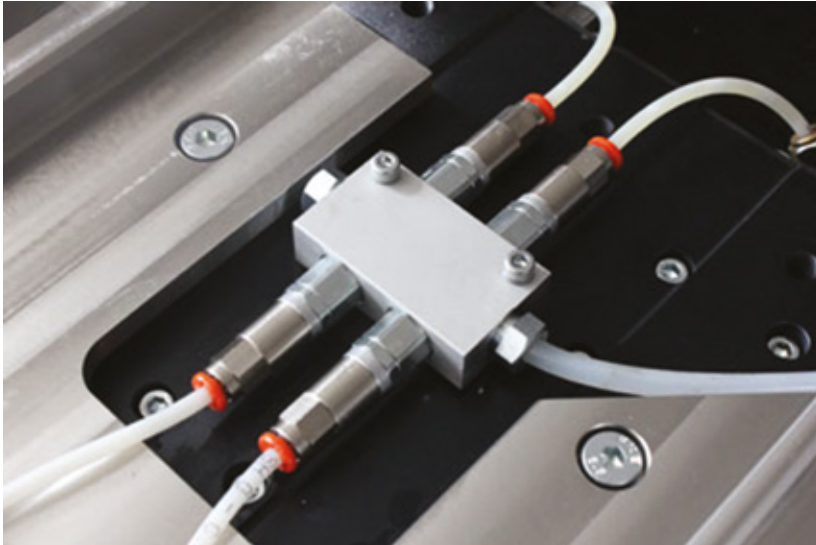

5. Mounting Block

Sinadrives offers the possibility to combine several axes in order to achieve complete portal solutions. The mounting blocks include the screws and pins to join easily two or more axes, with the aim of avoiding design time and difficulties.

■ AC01-Fxx000

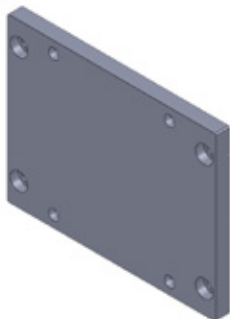

■ AC01-Sxx000

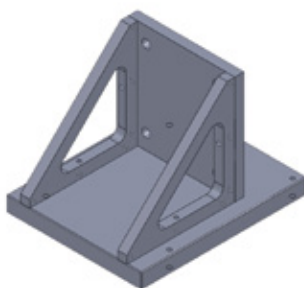

■ AC01-Lxx000

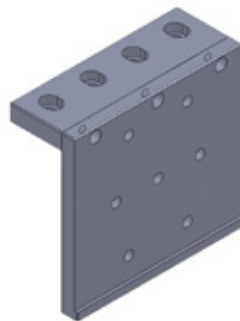

Designations

	AC01	F	L2	000
Mounting Block				
F: Flat mounting plate				
S: Square mounting block				
L: Lateral mounting block				
Base axis				
L2: MLL2				
E2: MLE2				
C3: MCE3				
...				
Version				
000: Generic				

6. Mounting Set

These pieces allow to fix easily Sinadrives stages to your machine body.

■ AC03-2501

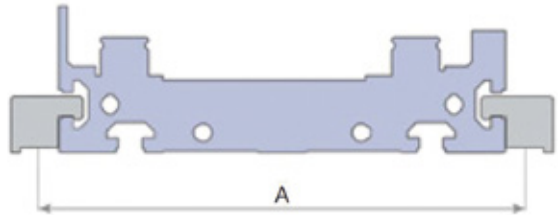
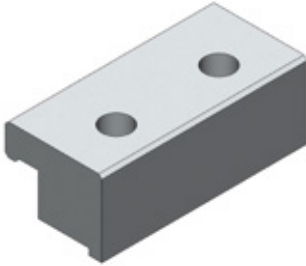

Linear unit	A (mm)
MLE2 / MLL2	152
MLE3 / MLL3	157
MLE5 / MLL5	204

■ AC03-2502 (For MLx2)



■ AC03-2503 (For MLx3)



■ AC03-2505 (For MLx5)



7. Nuts

■ KTM05

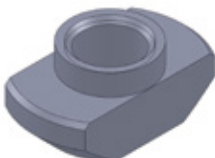

■ KTM06

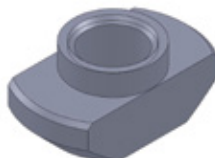

■ KTM08

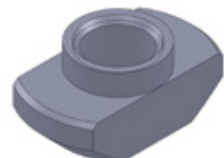

SINADRIVES Deutschland:

Unsöldstrasse 2 | 80538 Munich | Germany

Tel. +49 (0) 89 255 575 898 | Fax: +49 (0) 89 255 575 899

info@sinadrives.com

SINADRIVES Spain:

Avinguda Mas Pins, 164 Nave 6

17457 Riudellots de la Selva - Girona | Spain

Tel. +34 972 442 452 | Fax: +34 972 442 317

info@sinadrives.com

Accessories