

INDUSTRIAL & STORAGE SMART SOLUTIONS

TISSA

TISSA DINAMIC



DESCRIPCIÓN /

- Archivo horizontal versátil, robusto, amplio y funcional. En chapa metálica pintado con pintura epoxy.
- Mueble estándar de 10 cajones. Compuesto por dos módulos de 5 cajones, tapa y zócalo.
- Frontal de cajones con tirador en toda la longitud del cajón.
- Guías equipadas con rodamientos a bolas. Deslizamiento suave. 70% de extracción.
- Freno mecánico al final de las guías
- Cerradura con llave en cada módulo de cajones.
- Carga máxima: 25kg uniformemente repartidos en cada cajón.
- Disponible con 2, 3, 4, 5 cajones y 3 combinaciones de diferentes cajones.
- Apilable hasta 5 módulos.
- Disponibles diferentes opciones y accesorios.

COLOR /



RAL 9002 - Texture
Blanco Grisáceo

Posibilidad de otros colores bajo pedido

MUEBLE ESTÁNDAR /

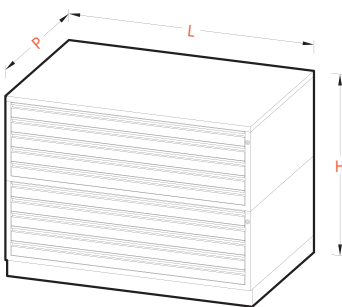

REF.	DESCRIPCIÓN	FORMATO	MEDIDAS		
			L	P	H
DNA0.10	Archivo Horizontal de 10 Cajones	DIN A0 Plus	1410	970	1034
DNA1.10	Archivo Horizontal de 10 Cajones	DIN A1 Plus	1130	810	1034

MÓDULOS DE AMPLIACIÓN /

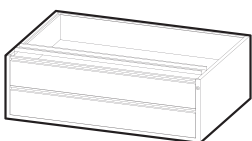

DNMA0.2 / DNMA1.2

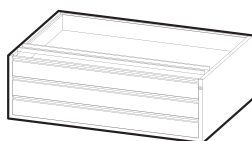

DNMA0.3 / DNMA1.3

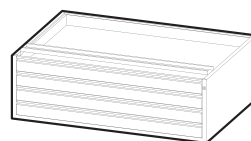

DNMA0.4 / DNMA1.4

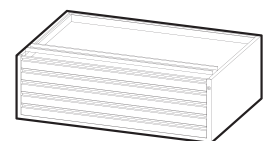

DNMA0.5 / DNMA1.5

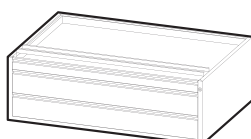

DNMA0.2.1 / DNMA1.2.1

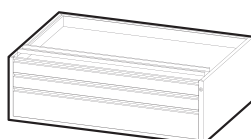

DNMA0.1.2 / DNMA1.1.2

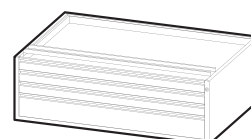

DNMA0.3.1 / DNMA1.3.1

CAJONES /

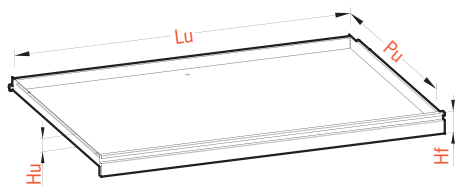

REF.	ALTURA FRONTAL	CARGA MÁX.	FORMATO	MEDIDAS ÚTILES		
	Hf	Cm		Lu	Pu	Hu
DN FRA0.84	84	25 Kg	DIN A0 Plus	1310 x 920 x 55	mm	
DN FRA0.105	105	25 Kg	DIN A0 Plus	1310 x 920 x 75	mm	
DN FRA0.140	140	25 Kg	DIN A0 Plus	1310 x 920 x 110	mm	
DN FRA0.168	168	25 Kg	DIN A0 Plus	1310 x 920 x 135	mm	
DN FRA0.210	210	25 Kg	DIN A0 Plus	1310 x 920 x 180	mm	
DN FRA1.84	84	25 Kg	DIN A1 Plus	1030 x 760 x 55	mm	
DN FRA1.105	105	25 Kg	DIN A1 Plus	1030 x 760 x 75	mm	
DN FRA1.140	140	25 Kg	DIN A1 Plus	1030 x 760 x 110	mm	
DN FRA1.168	168	25 Kg	DIN A1 Plus	1030 x 760 x 135	mm	
DN FRA1.210	210	25 Kg	DIN A1 Plus	1030 x 760 x 180	mm	

COMPLEMENTOS /



- Tapa en chapa de acero (SMA0 / SMA1)
- Zócalo en chapa de acero (ZMA0 / ZMA1)



- Base con patas (STMA0 / STMA1)



- Base con ruedas (WHMA01)

OPCIONES EXTRA /



- Cajones de 40Kg (uniformemente repartidos)



- Sistema anti-vuelco



- Guías telescópicas 45Kg



- Frontal abatible

ACCESORIOS /



- **AH40** Separadores (x12 u.)



- **PWA0 / PWA1** Pisapapeles

Salleras **TISSA** Industrial S.A.

Ctra. Girona - Planes - Km 4,5
17150 Sant Gregori (Girona)

T (+34) 972 42 80 58
F (+34) 972 42 87 33

www.salleras-tissa.com
info@salleras-tissa.com

