



Descripción/ Tobogán figurativo pececito.

- Materiales/**
- Estructura de polietileno de alta densidad, libre de mantenimiento y antigraffiti. Con decoración grabada.
 - Pista de acero inoxidable.



Description/ The little fish-shaped slide.

- Materials/**
- Maintenance-free, anti-graffiti, HDPE structure with engraved decoration.
 - Stainless steel slide ramp.



Description/ Toboggan représentant un petit poisson.

- Matériaux/**
- Structure en polyéthylène haute densité, sans entretien et antigraffiti. Décoration gravée.
 - Glissière en acier inoxydable.

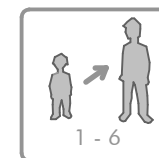
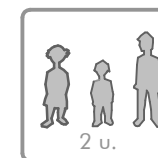
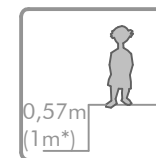
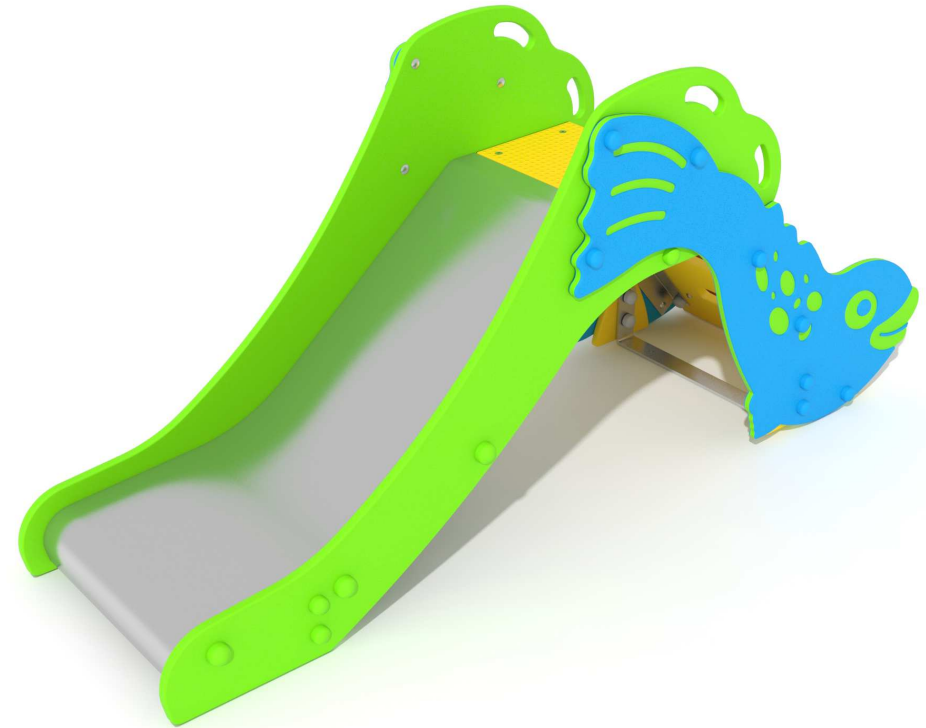

*La superficie amortiguadora debe tener una altura de caída crítica de 1m para compensar el movimiento forzado.

*Safety surface must have a 1 m critical falling height to compensate the forced movement.

*Le revêtement amortissant doit avoir une hauteur de chute critique 1 mètre pour compenser le mouvement forcé.



ESPACIO DE SEGURIDAD / ALTURA DE CAIDA LIBRE
SAFETY AREA / FREE HEIGHT OF FALL
ZONE DE SECURITÉ / HAUTEUR DE CHUTE LIBRE

A -2,2 m² / 1 m*
B -10,8 / 0,57 m

Superficie según EN-1176-1
Surface according to EN-1176-1
Revêtement conformément à la Norme EN-1176-1

*La superficie amortiguadora debe tener una altura de caída crítica de 1 m para compensar el movimiento forzado.
*Safety surface must have a 1 m critical falling height to compensate the forced movement.
*Le revêtement amortissant doit avoir une hauteur de chute critique 1 mètre pour compenser le mouvement forcé.

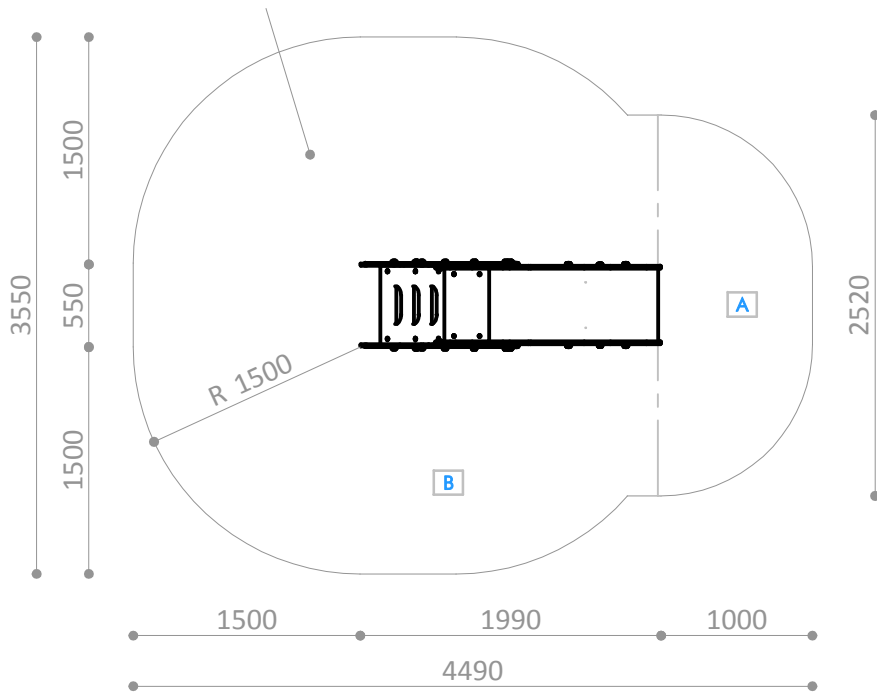

R4808

Pieza más grande

Biggest part

La plus grande pièce

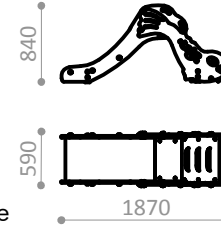

R4808

Pieza más pesada

Heaviest part

La pièce la plus lourde



55 Kg.

R4808A

Suelo de hormigón

Concrete ground

Fixation sur béton

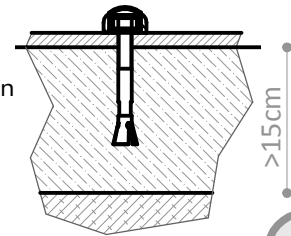

x4

R4808E

Otros suelos

Other grounds

Autres sols

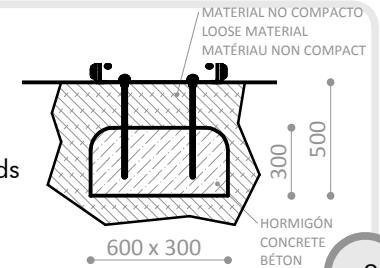

x2

Disponibilidad de repuestos durante 10 años.
Spare parts available for 10 years.
Disponibilité de pièces de rechange pendant 10 ans.

Industrias Agapito se reserva el derecho a modificar sin previo aviso los elementos descritos en este documento.
Industrias Agapito reserves the right to change the items described in this document without prior notice.
Industrias Agapito se réserve le droit de modifier à tout moment et sans préavis les éléments décrits dans le présent document.



AGAPLAY

R4808

TOBOGÁN EL PESECITO
THE LITTLE FISH SLIDE
TOBOGGAN LE PETIT POISSON

FICHA TECNICA
TECHNICAL SHEET
FICHE TECHNIQUE
FT-R4808rev08 - 3/3

