



Descripción/ Tobogán figurativo Elefante.

- Materiales/**
- Estructura de polietileno de alta densidad, libre de mantenimiento y antigraffiti. Con decoración grabada.
 - Pista de acero inoxidable.



Description/ Elephant-shaped slide

- Materials/**
- Maintenance-free, anti-graffiti, HDPE structure with engraved decoration.
 - Stainless steel slide ramp.



Description/ Toboggan représentant un éléphant.

- Matériaux/**
- Structure en polyéthylène haute densité, sans entretien et antigraffiti. Décoration gravée.
 - Glissière en acier inoxydable.

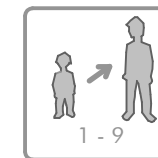
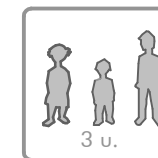
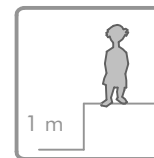
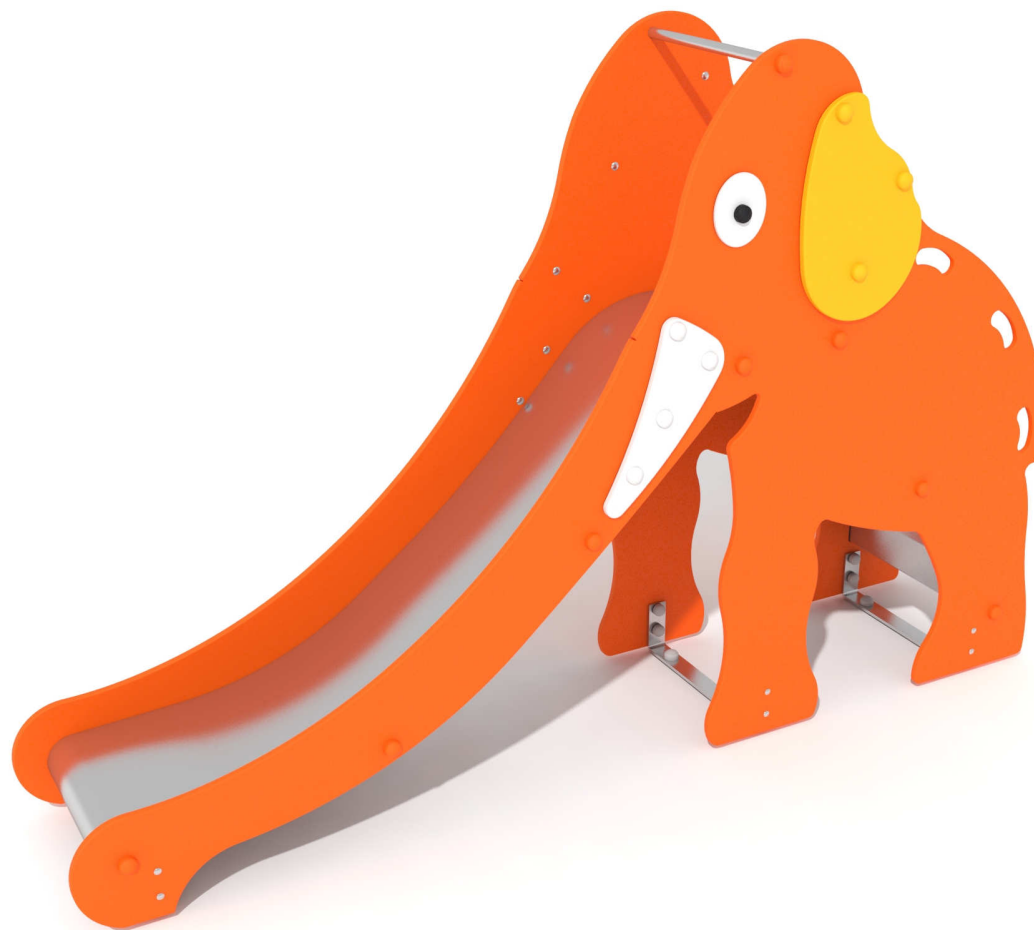

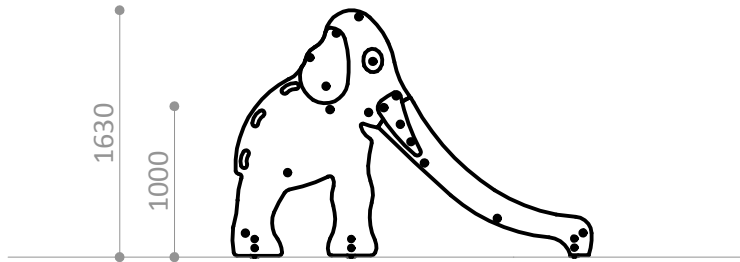

ESPACIO DE SEGURIDAD / ALTURA DE CAIDA A LIBRE
SAFETY AREA / FREE HEIGHT OF FALL
ZONE DE SECURITÉ / HAUTEUR DE CHUTE LIBRE

15,3 m² / 1 m

Superficie según EN-1176-1
Surface according to EN-1176-1
Revêtement conformément à la Norme EN-1176-1

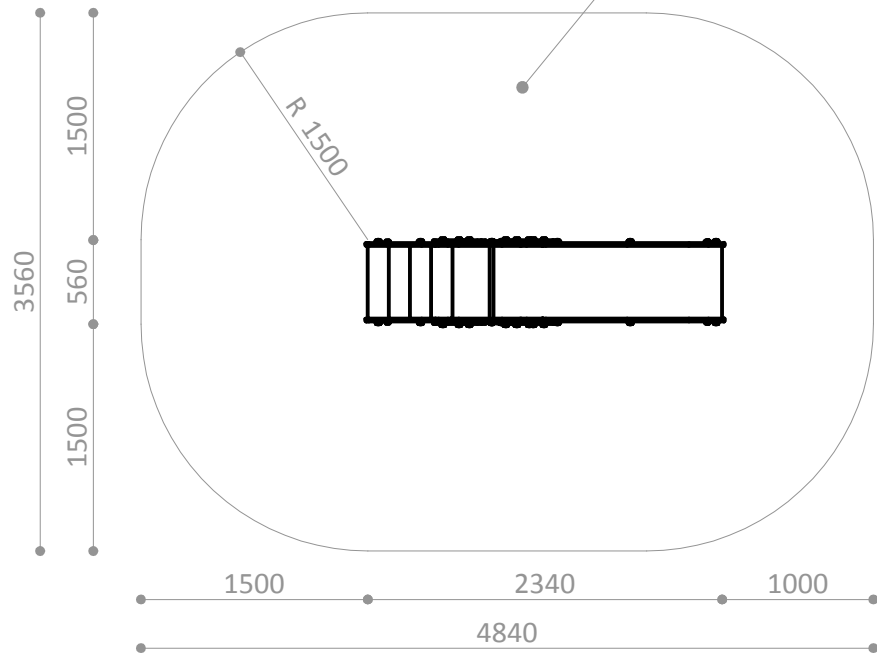

R4815E-01 ELEFANTE

Pieza más grande

Biggest part

La plus grande pièce

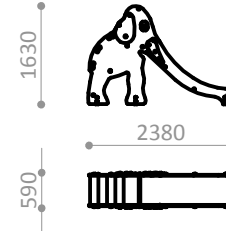

R4815E-01 ELEFANTE

Pieza más pesada

Heaviest part

La pièce la plus lourde



110 Kg.

R4815A

Suelo de hormigón

Concrete ground

Fixation sur béton

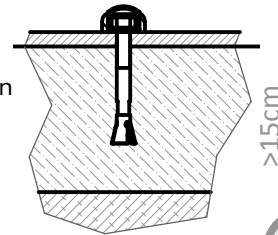

x6

R4815E

Otros suelos

Other grounds

Autres sols

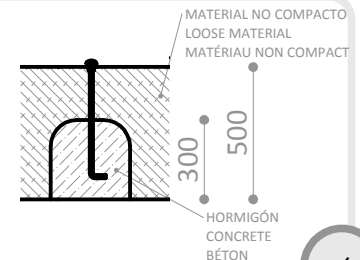

x6

Disponibilidad de repuestos durante 10 años.
Spare parts available for 10 years.
Disponibilité de pièces de rechange pendant 10 ans.

Industrias Agapito se reserva el derecho a modificar sin previo aviso los elementos descritos en este documento.
Industrias Agapito reserves the right to change the items described in this document without prior notice.
Industrias Agapito se réserve le droit de modifier à tout moment et sans préavis les éléments décrits dans le présent document.

