 **Descripción/** Tobogán de polietileno de alta densidad con estructura de madera tratada.

- Materiales/**
- Estructura de madera Pino Rojo del Norte, tratada en autoclave a nivel P4 y acabada con lásur, protector de la madera a poro abierto, hidrófugo, fungicida y con doble filtro anti U.V.
 - Tobogán de polietileno de alta densidad.

 **Description/** High density polyethylene slide with treated wood structure.

- Materials/**
- P4 Vacuum pressure treated Pine wood structure, with open pore, waterproof, fungicide and ultraviolet radiation protection.
 - Polyethylene slide.

 **Description/** Toboggan en polyéthylène, avec structure en bois traité.

- Matériaux/**
- Structure en Pin du Nord, traité en autoclave et finition lasurée, protecteur du bois à pores ouverts, hydrofuge, fongicide et avec double protection U.V
 - Toboggan en polyéthylène.

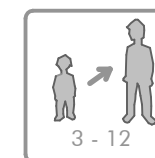
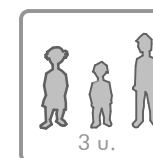
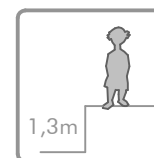

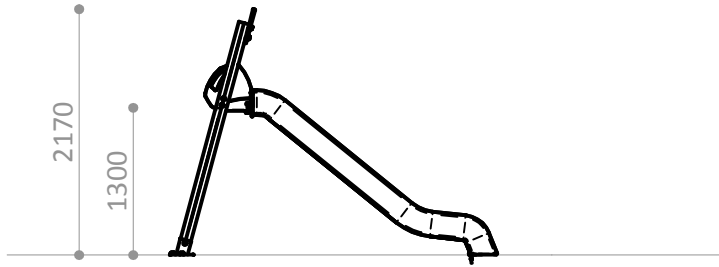

ESPACIO DE SEGURIDAD / ALTURA DE CAIDA A LIBRE
SAFETY AREA / FREE HEIGHT OF FALL
ZONE DE SECURITÉ / HAUTEUR DE CHUTE LIBRE

22 m2 / 1,3 m

Superficie según EN-11 76-1
Surface according to EN-1176-1
Revêtement conformément à la Norme EN-1176-1

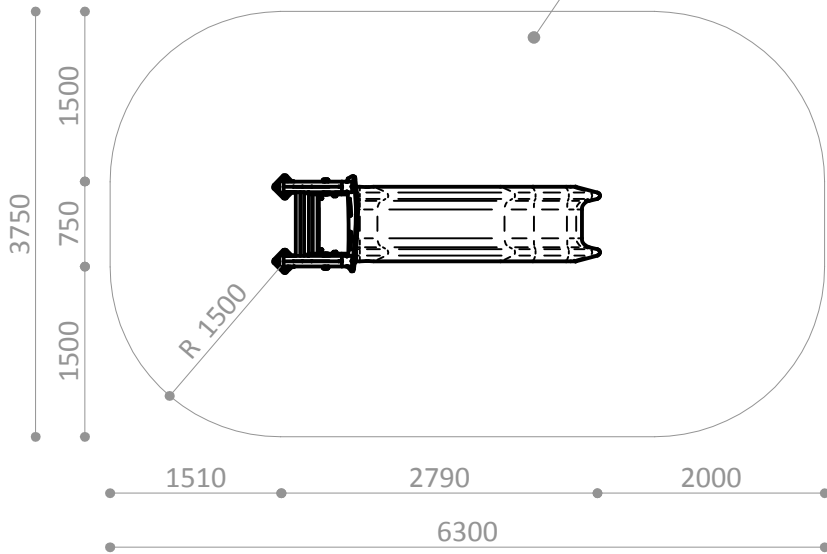

TOBOGÁN POLIETILENO

Pieza más grande

Biggest part

La plus grande pièce

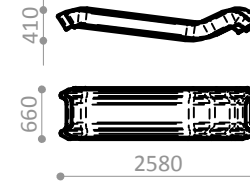

ACCESO

Pieza más pesada

Heaviest part

La pièce la plus lourde



46 Kg.

R4823A

Suelo de hormigón

Concrete ground

Fixation sur béton

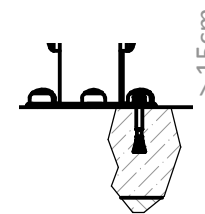

x10

R4823E

Otros suelos

Other grounds

Autres sols

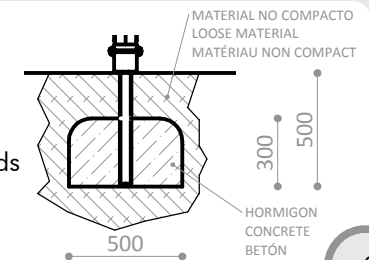

x2

Disponibilidad de repuestos durante 10 años.
Spare parts available for 10 years.
Disponibilité de pièces de rechange pendant 10 ans.

Industrias Agapito se reserva el derecho a modificar sin previo aviso los elementos descritos en este documento.
Industrias Agapito reserves the right to change the items described in this document without prior notice.
Industrias Agapito se réserve le droit de modifier à tout moment et sans préavis les éléments décrits dans le présent document.

