 **Descripción/** Multijuego con 1 torre de 3 m de altura con tejado.
Juegos adicionales: Tobogán de polietileno, escalera de acceso y columpio.

- Materiales/**
- Pino Rojo del Norte, tratada en autoclave a nivel P4 y acabada con lásur, protector de la madera a poro abierto, hidrófugo, fungicida y con doble filtro anti U.V.
 - Polietileno de alta densidad, libre de mantenimiento y antigraffiti.
 - Plataforma en polietileno revestido de caucho antideslizante.
 - Partes metálicas de acero inoxidable, acero galvanizado y acero con pintura de poliéster termoendurecida.
 - Asiento plano en caucho amortiguador de impactos con alma interior de aluminio y cadenas de acero inoxidable.

 **Description/** Playset with 1 tower 3m high.
Additional games: HDPE slide, stairs and swing.

- Materials/**
- P4 Vaccum pressure treated Pine wood structure, with open pore, waterproof, fungicide and ultraviolet radiation lasur protection.
 - Anti-graffiti, maintenance free HDPE.
 - Rubber covered HDPE in platform.
 - Stainless, thermohardened painted Steel and galvanized Steel metal parts.
 - Rubber seat with steel core and stainless steel chains.

 **Description/** Structure multijeu avec 1 tour de 3 m de hauteur avec toit.
Jeux additionnels: toboggan en polyéthylène, escalier et portique.

- Matériaux/**
- Structure en Pin du Nord, traité en autoclave et finition lasurée, protecteur du bois à pores ouverts, hydrofuge, fongicide et avec double protection U.V.
 - Polyéthylène haute densité, libre d'entretien et antigraffiti.
 - Plate-forme revêtue de caoutchouc antidérapant.
 - Pièces métalliques en acier inoxydable, acier galvanisé et acier avec peinture polyester thermodurcie.
 - Siège de sécurité en caoutchouc antichoc avec âme intérieure en aluminium et chaînes en acier inoxydable.

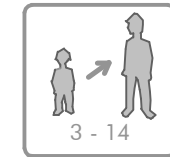
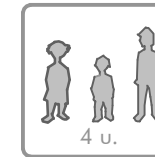
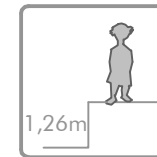

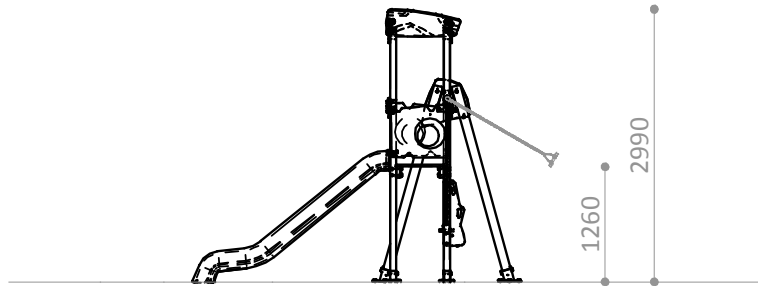

ESPACIO DE SEGURIDAD / ALTURA DE CAIDA LIBRE
SAFETY AREA / FREE HEIGHT OF FALL
ZONE DE SECURITÉ / HAUTEUR DE CHUTE LIBRE

A - 25,5 m² / 1,26 m
B - 5,5m² / 1 m

TORRE R4208-01

Pieza más grande

Biggest part

La plus grande pièce

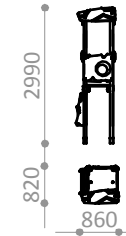

TORRE R4208-01

Pieza más pesada

Heaviest part

La pièce la plus lourde



66 Kg.

ÁREA LIBRE DE OBSTÁCULOS
AREA FREE FROM OBSTACLES
ZONE LIBRE D' OBSTACLES

Superficie según EN-1176-1
Surface according to EN-1176-1
Revêtement conformément à la Norme EN-1176-1

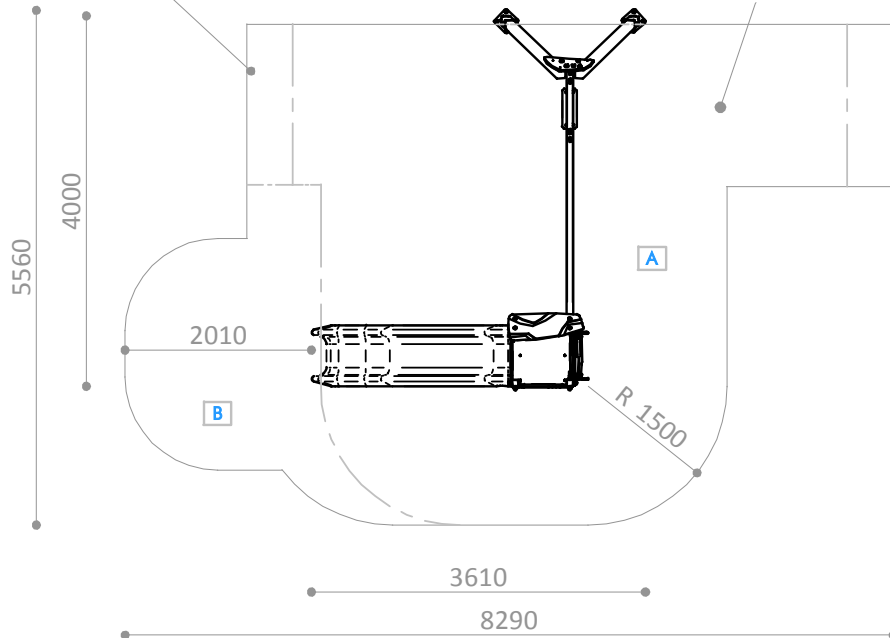

R4218PA

Suelo de hormigón

Concrete ground

Fixation sur béton

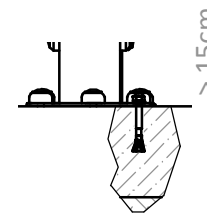

x26

R4218PE

Otros suelos

Other grounds

Autres sols

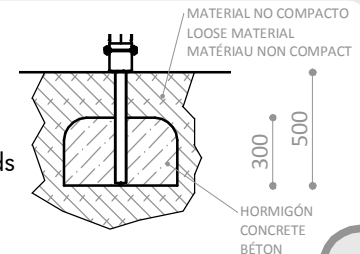

x 8



AP-01-EST-046

ESTRUCTURA VELETA VOLADOR

Park's
espais lúdics i urbans



C. Pedret, 1 · 17007 GIRONA
T +34 972 17 00 13
M +34 609 37 73 55

   
@parks3000

www.parks3000.com

AP-01-EST-046

ESTRUCTURA VELETA VOLADOR

Park's
espais lúdics i urbans



C. Pedret, 1 · 17007 GIRONA
T +34 972 17 00 13
M +34 609 37 73 55

@parks3000

www.parks3000.com