

 **Función/** Ejercicio cardiovascular. Para ejercitación del tren inferior. Avalado por médico rehabilitador y fisioterapeuta.

- Materiales/**
- Estructura de acero galvanizado con pintura de poliéster termoendurecida.
 - Polietileno de alta densidad con recubrimiento de goma antideslizante, libre de mantenimiento y antigraffiti.
 - Tornillería de acero inoxidable.
 - Instrucciones de uso grabadas.

 **Function/** Cardio exercise for lower body warm up. Endorsed by a rehabilitation physiatrist and physician.

- Materials/**
- Thermohardened polyester painted galvanized steel structure.
 - Maintenance free, antigraffiti, rubber covered HDPE turning device.
 - Stainless steel fixings.
 - Sign included.

 **Fonction/** Exercice cardio-vasculaire pour échauffer la partie inférieure du corps. Avalisé par un médecin rééducateur et un physiothérapeute.

- Matériaux/**
- Structure en acier galvanisé avec peinture polyester thermodurcie.
 - Polyéthylène haute densité, sans entretien et antigraffiti, avec un revêtement en caoutchouc antidérapant.
 - Visserie en acier inoxydable.
 - Panneau explicatif d'emploi.

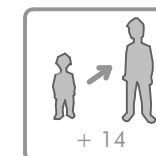
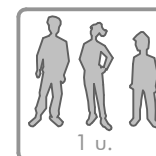
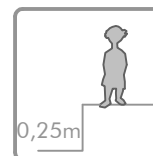

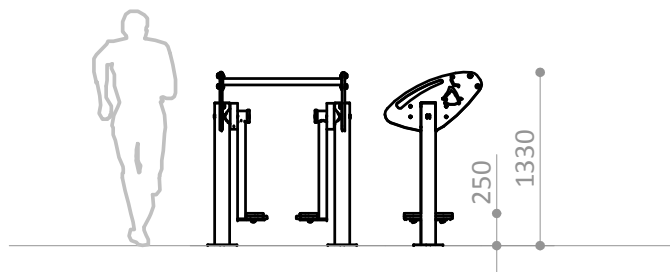

ÀREA DE MOVIMIENTO / ALTURA DE CAIDA LIBRE
MOVEMENT ZONE/ FRE E HEIGHT OF FALL
ZONE DE MOUVEMENT / HAUTEUR DE CHUTE LIBRE

13,75 m² / 0,25 m

Superficie según EN 16630
Surface according to EN 16630
Revêtement conformément à la Norme EN 16630

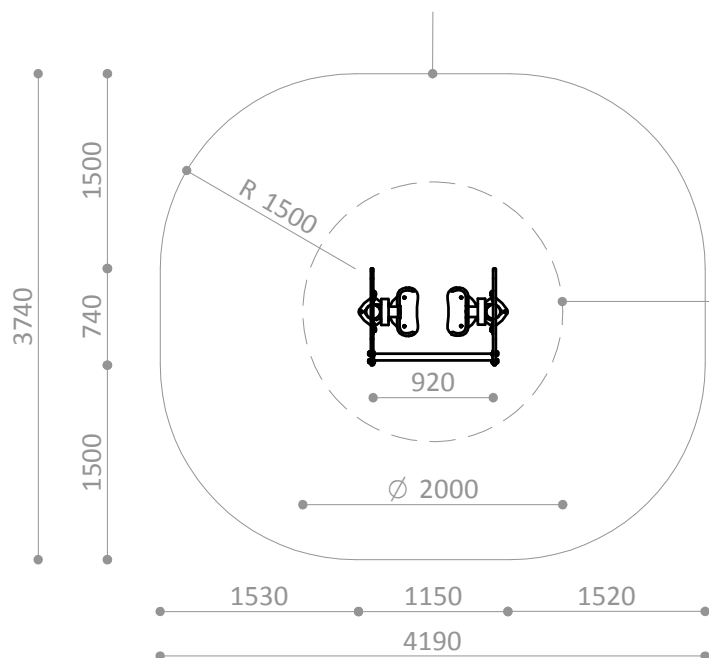

R7226

Pieza más grande

Biggest part

La plus grande pièce

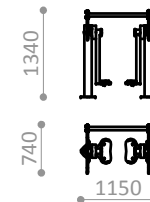

R7226

Pieza más pesada

Heaviest part

La pièce la plus lourde

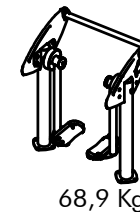

R7226A

Suelo de hormigón

Concrete ground

Fixation sur béton

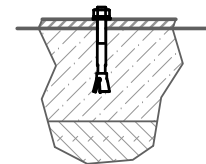

x8

R7226E

Otros suelos

Other grounds

Autres sols

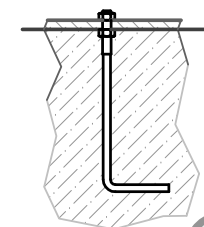

x8

ÁREA DE EJERCICIO
EXERCISE ZONE
ZONE D'EXERCICE

Peso máximo del usuario = 150 Kg.
Maximum user weight = 150 Kg.
Poids maximum de l'utilisateur = 150 Kg
Höchstgewicht des Benutzers = 150 Kg



AP-03-GIM-003

GIMNÀS CAMINADOR EN SUSPENSIÓ

Park's
espais lúdics i urbans

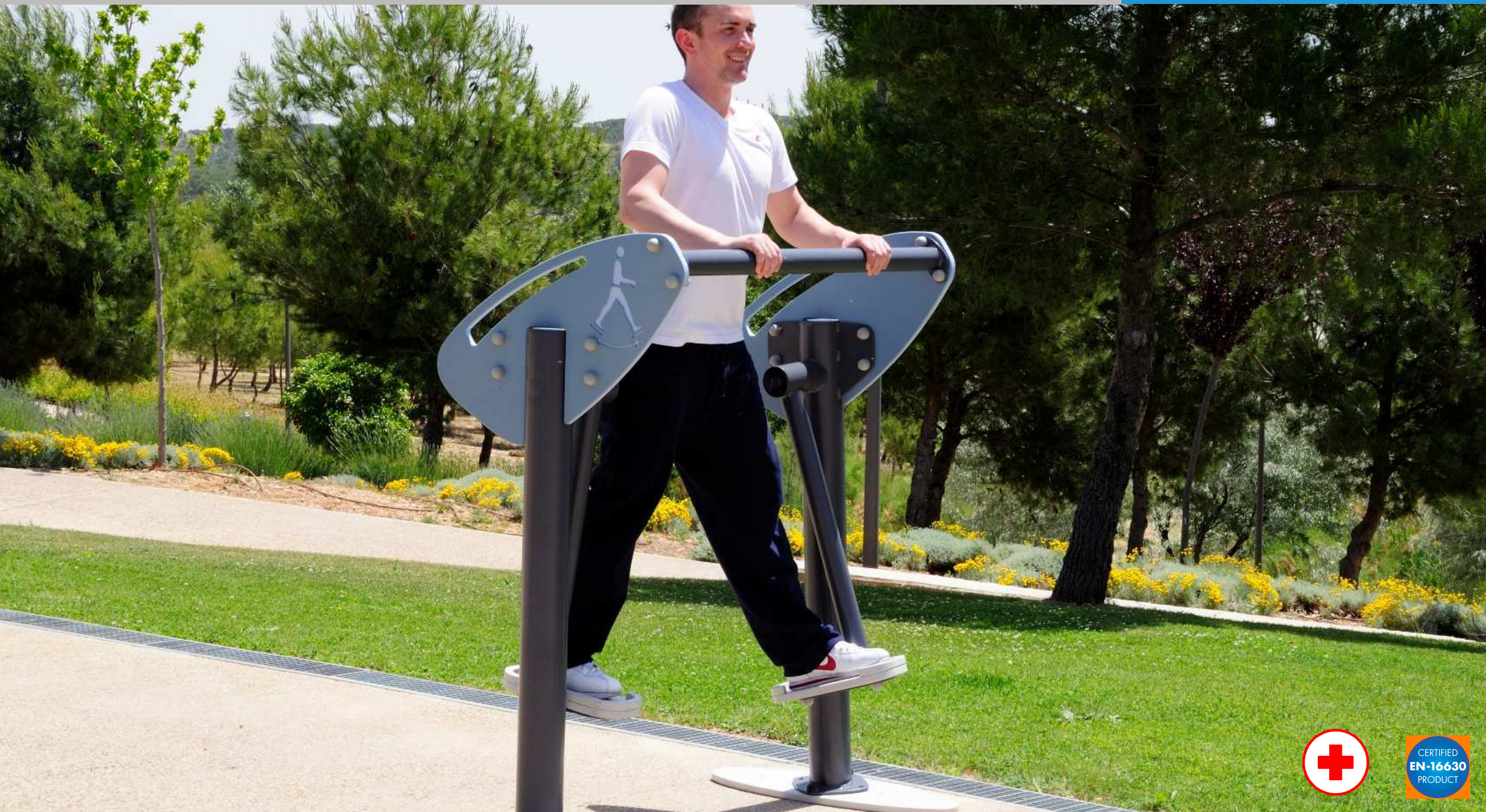

C. Pedret, 1 · 17007 GIRONA
T +34 972 17 00 13
M +34 609 37 73 55



@parks3000

www.parks3000.com