



ACTIVIDADES



DATOS TÉCNICOS

DIMENSIONES:

2,38 x 5,76 x 2,49 m





SUPERFICIE DE JUEGO:

5,46 x 9,21 m

COMPONENTES:

Torres; Tobogán Paris 80; Tunnel; Muro de red. Rampa de subida.

Accesibilidad:

		Motriz	<input checked="" type="checkbox"/>	<input type="checkbox"/>	<input type="checkbox"/>	<input type="checkbox"/>
		Sensorial	<input checked="" type="checkbox"/>	<input type="checkbox"/>	<input type="checkbox"/>	<input type="checkbox"/>
		Mental	<input checked="" type="checkbox"/>	<input type="checkbox"/>	<input type="checkbox"/>	<input type="checkbox"/>

INSTALACIÓN



1,95 x 0,74 x 2,56 m



292 kg / 128 kg



5 h / 3 operarios



De 3 a 7 años



16 usuarios

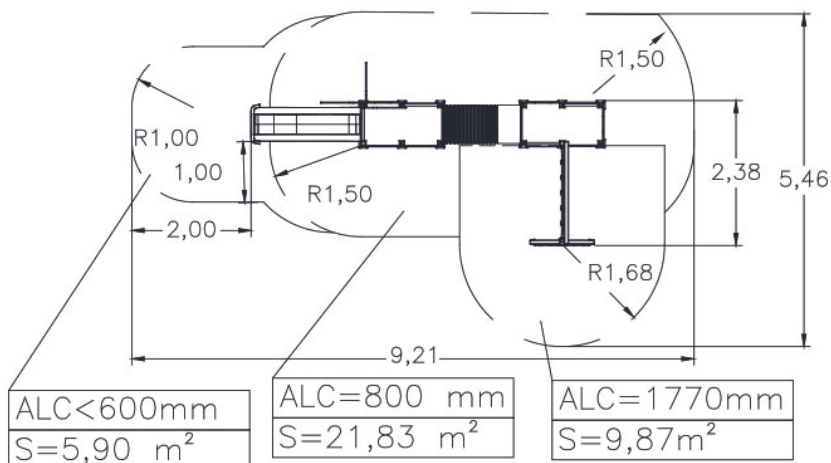
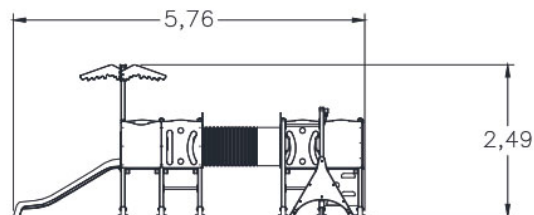

IMÁGENES

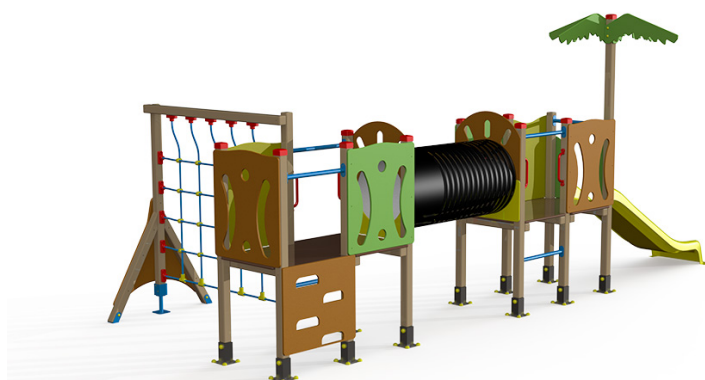

NORMA Y CERTIFICADOS:

