

1:75

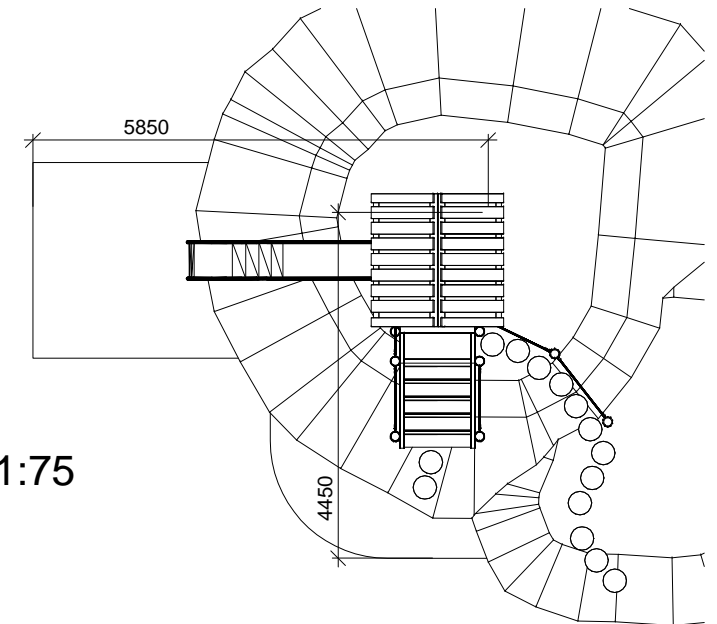

1:75

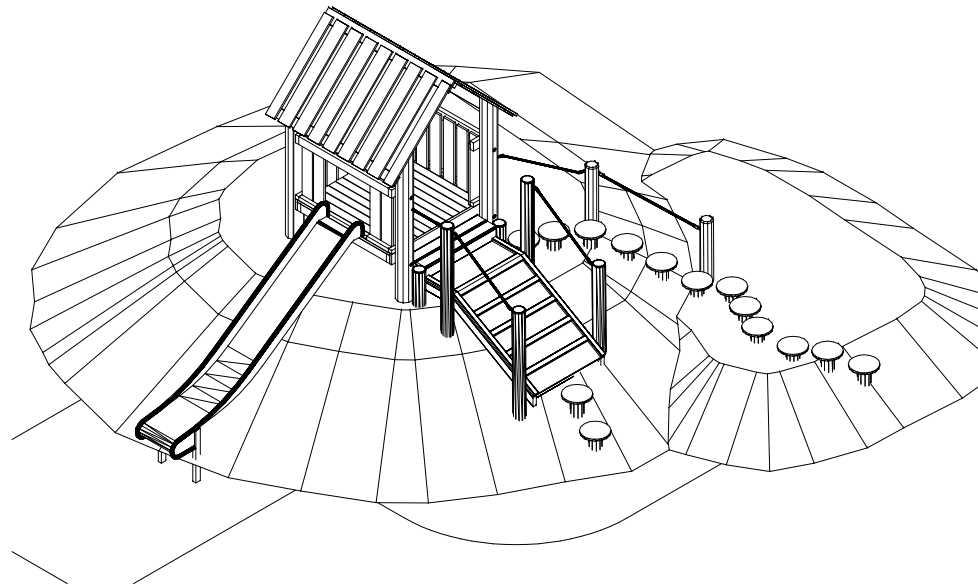

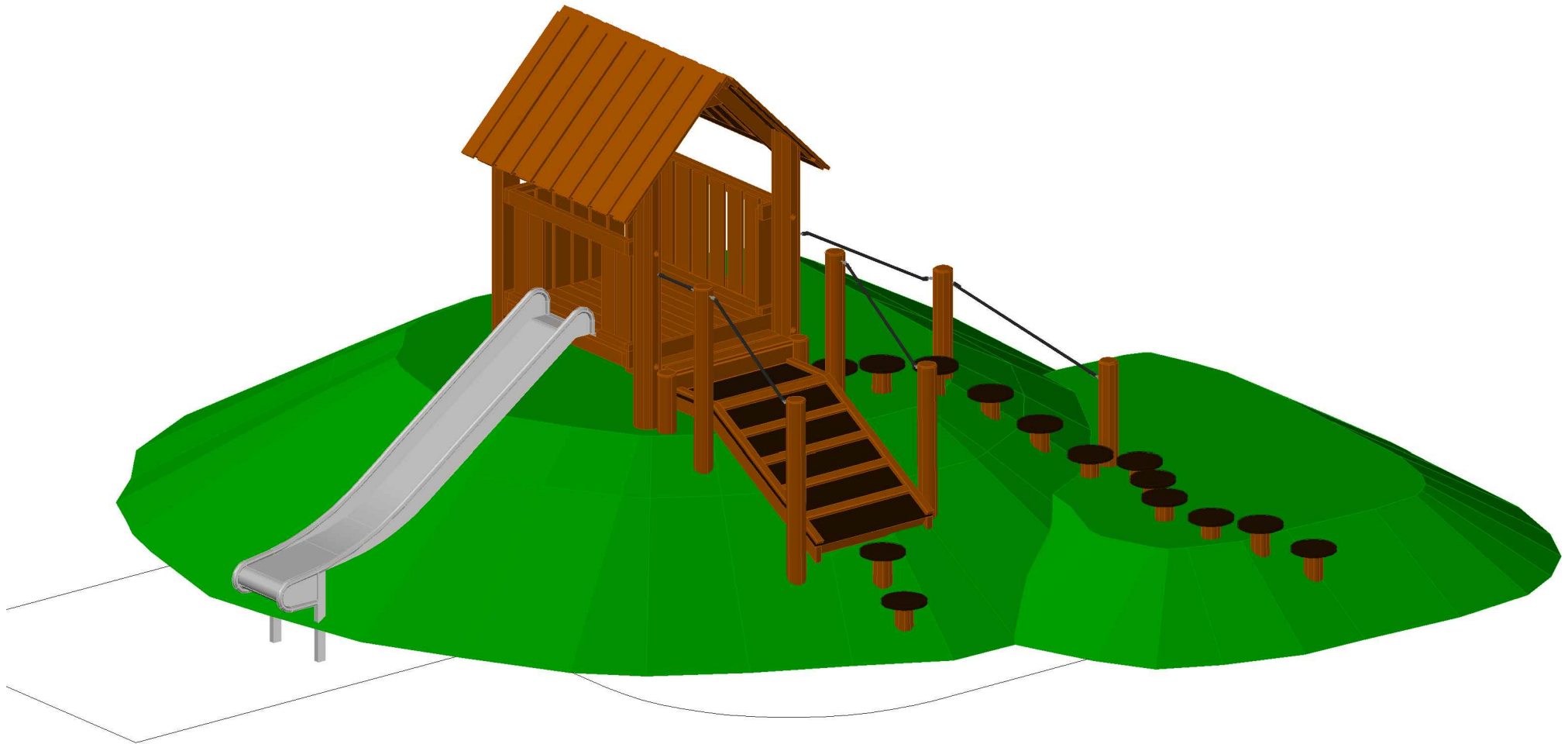
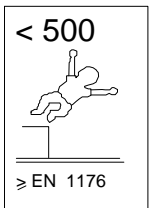
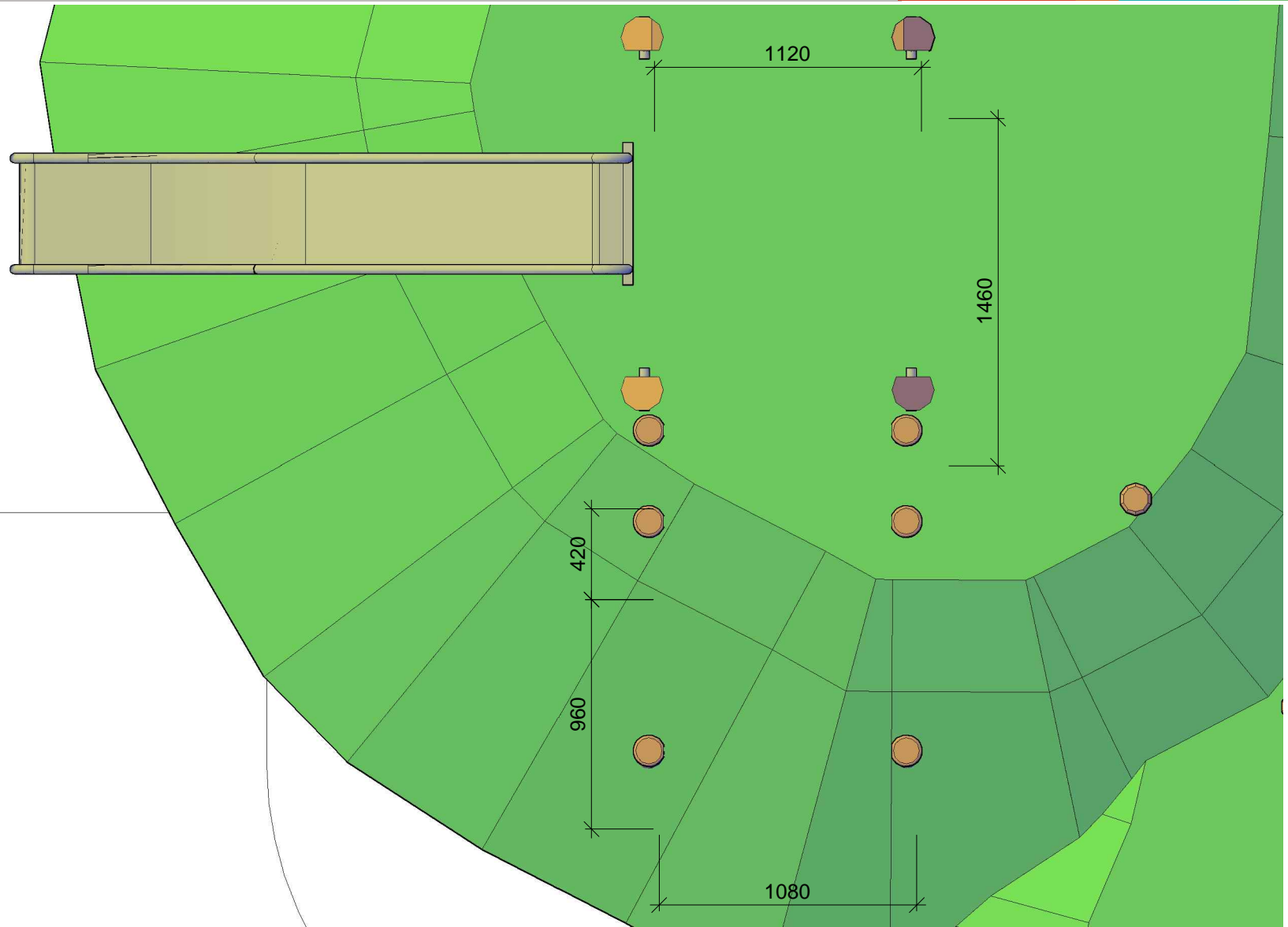
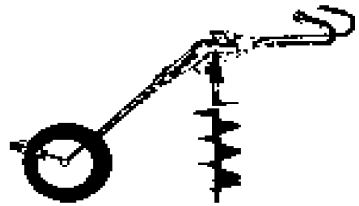

1:50

Parts list		
Mrk.	QTY	Part.no
1	2	160-180-2600-z
2	2	160-180-2600-z
3	2	120-140-1200-k
4	4	120-140-2000-k
5	2	120-140-1600

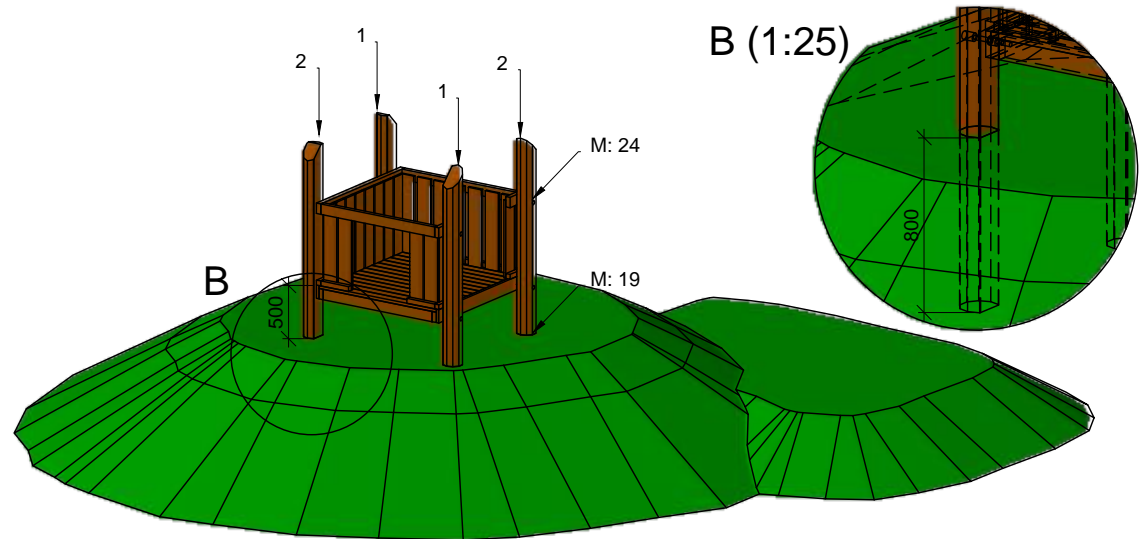

< 500



≥ EN 1176

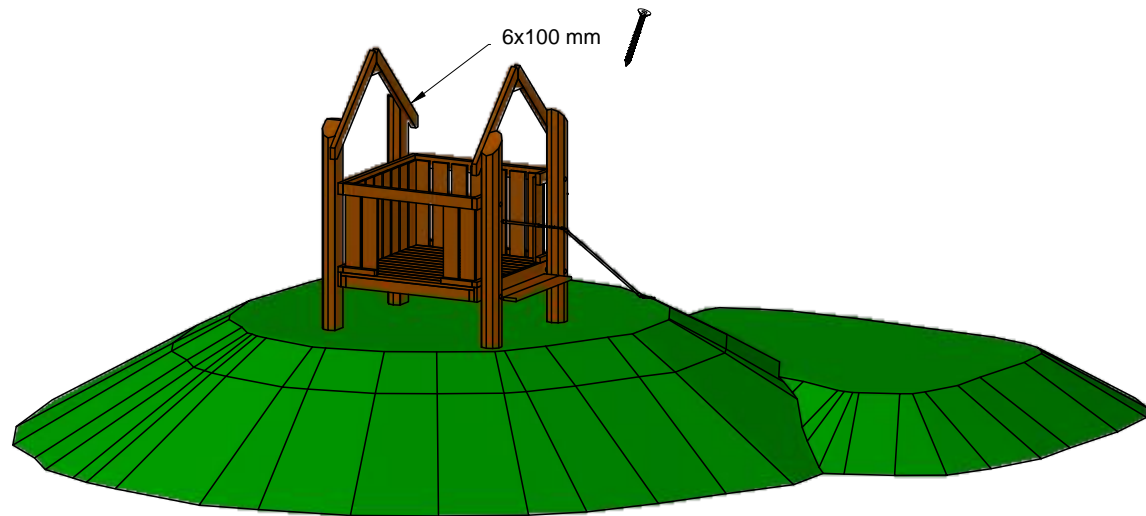

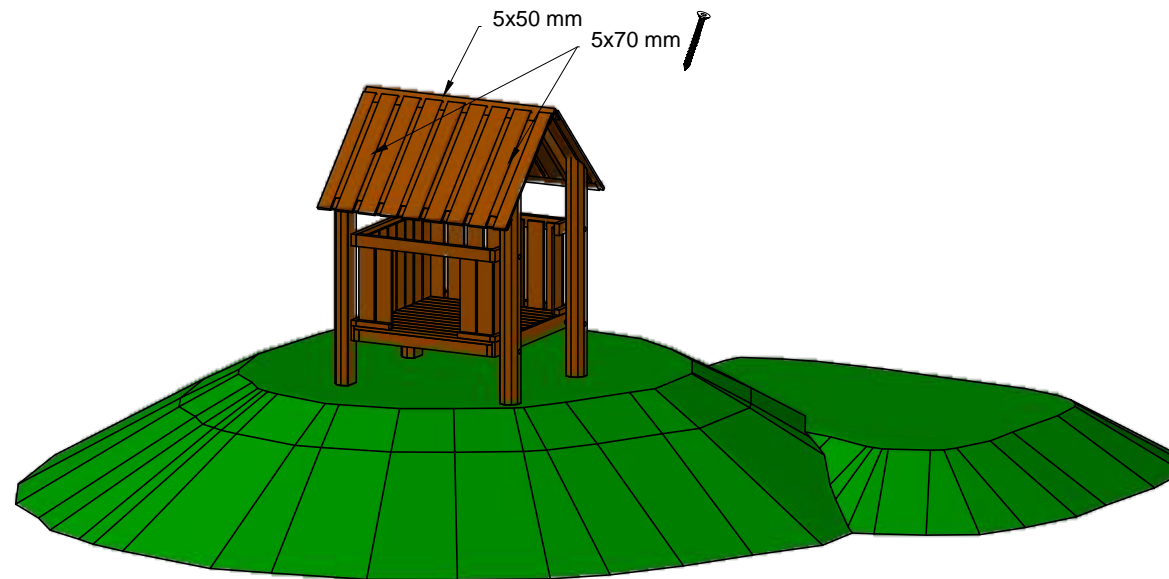
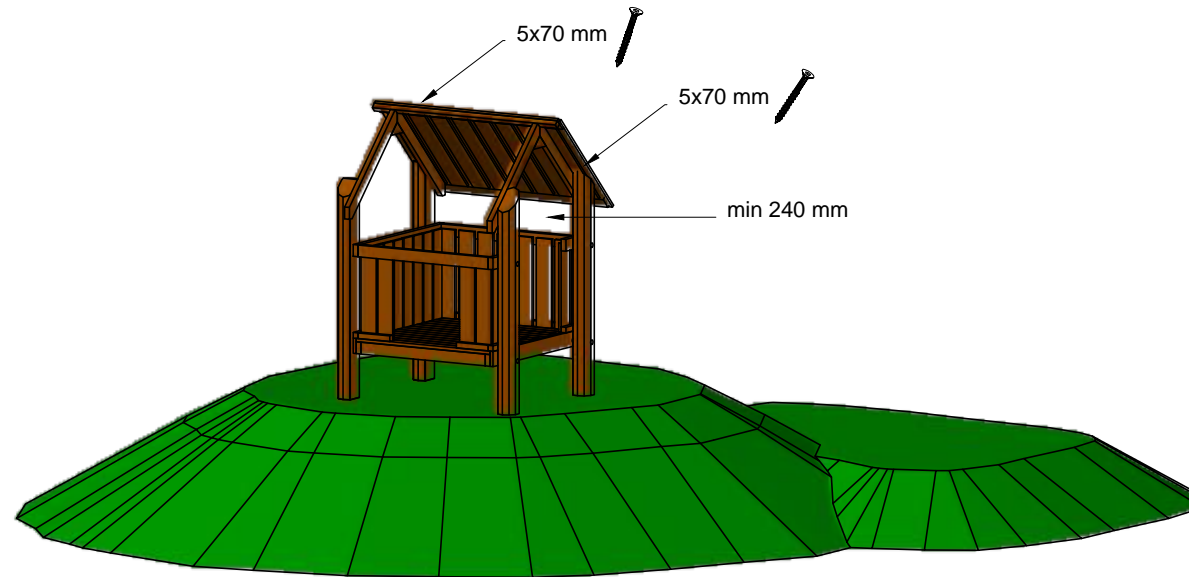
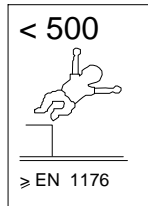

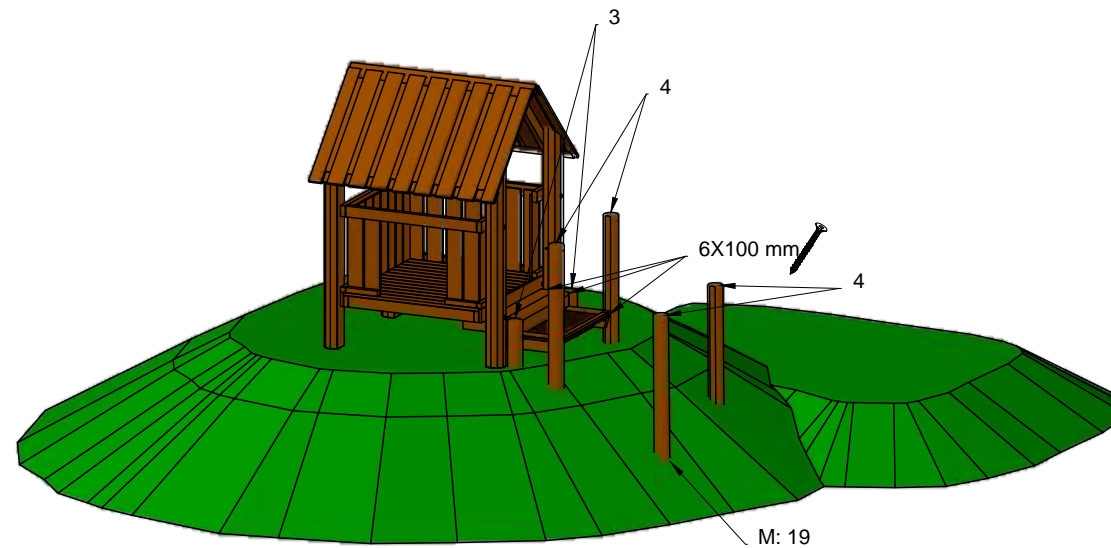

< 500

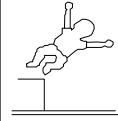

> EN 1176

Parts list		
Mrk.	QTY	Part.no
1	2	160-180-2600-z
2	2	160-180-2600-z
3	2	120-140-1200-k
4	4	120-140-2000-k
5	2	120-140-1600

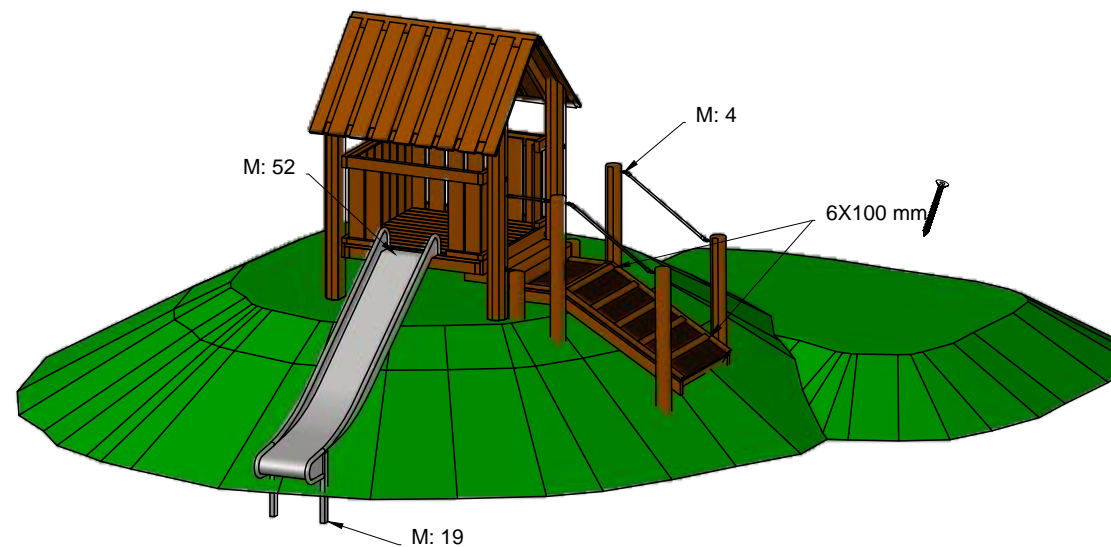

Parts list		
Mrk.	QTY	Part.no
1	2	160-180-2600-z
2	2	160-180-2600-z
3	2	120-140-1200-k
4	4	120-140-2000-k
5	2	120-140-1600
6	16	LE 42504

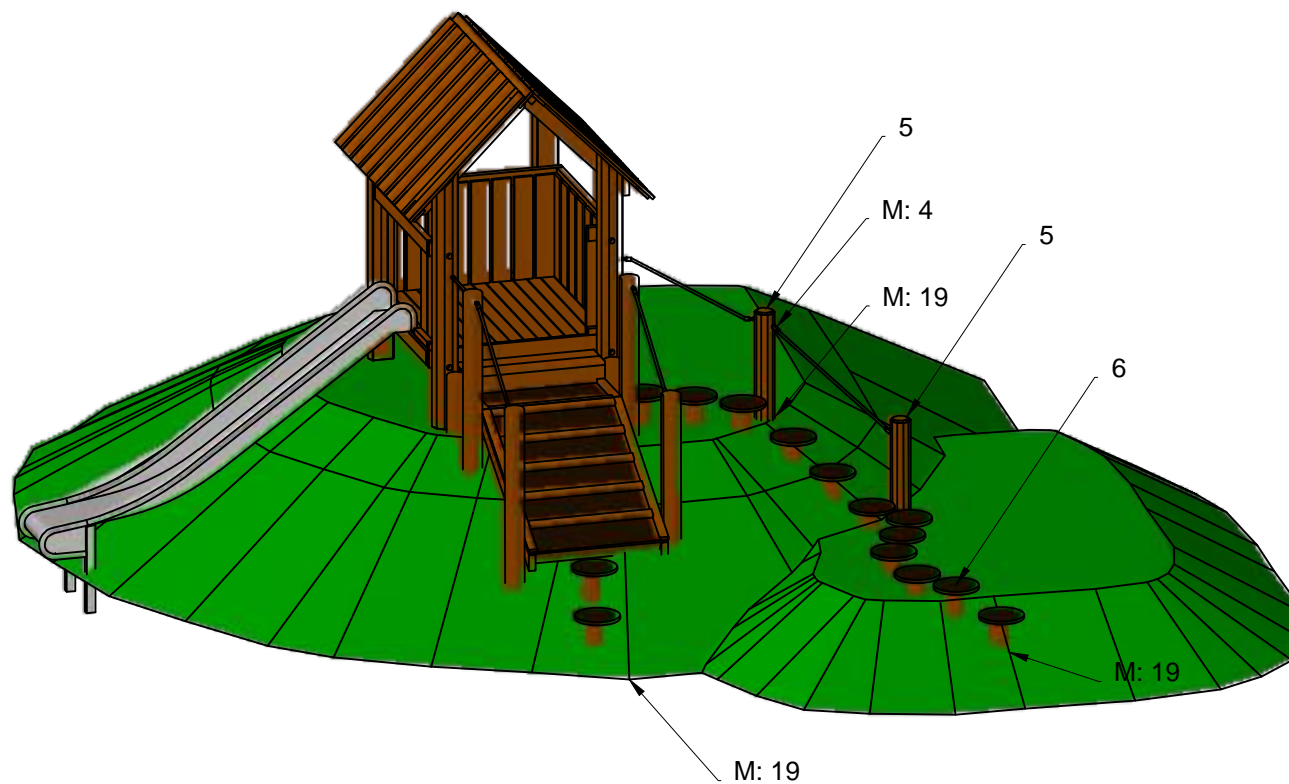

< 500



≥ EN 1176