

VISAT

Jordi Paulí Collado - ARQUITECTE
 Av. Jaume I, 28. 4art 1ª
 17001 GIRONA 972 412 836

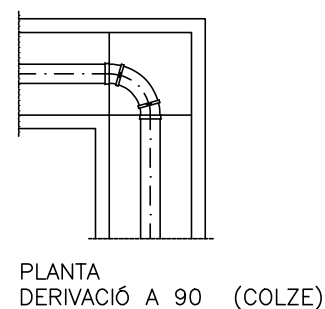

PECES ESPECIALS

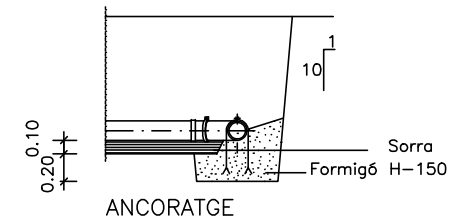
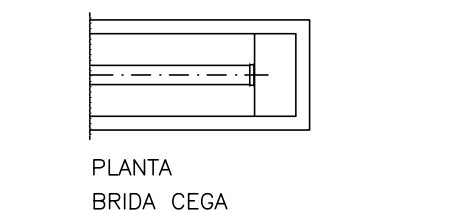
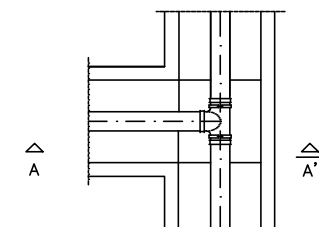
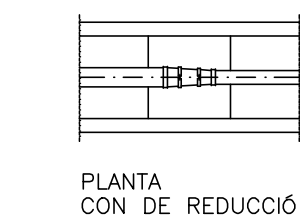
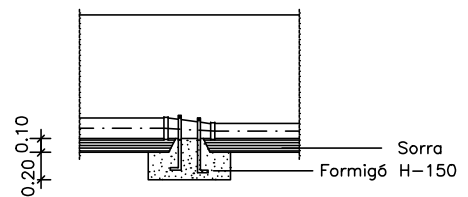
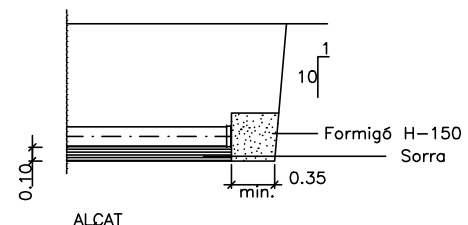

PLANTA
DERIVACIÓ EN "T"

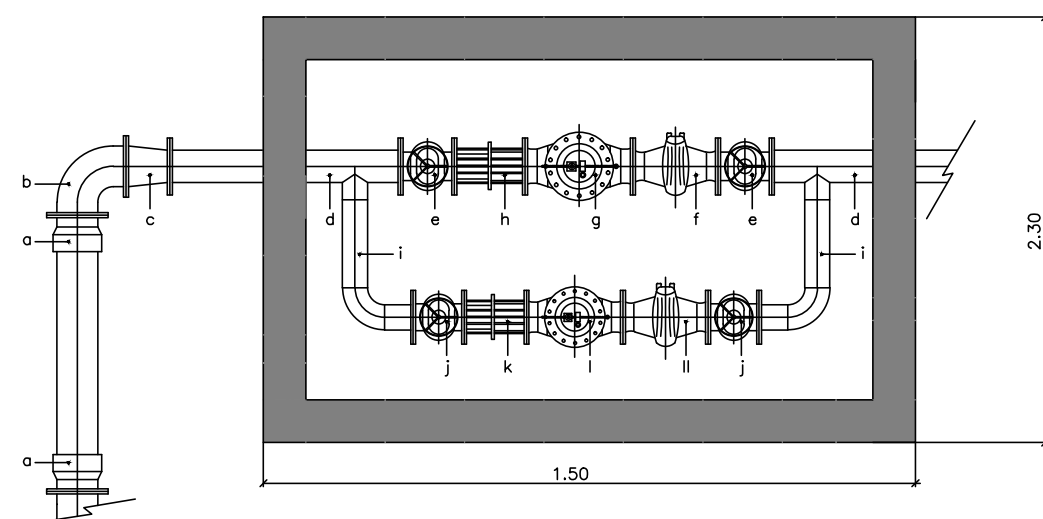
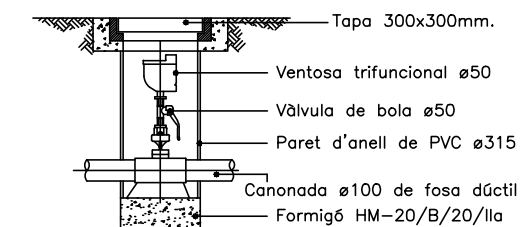
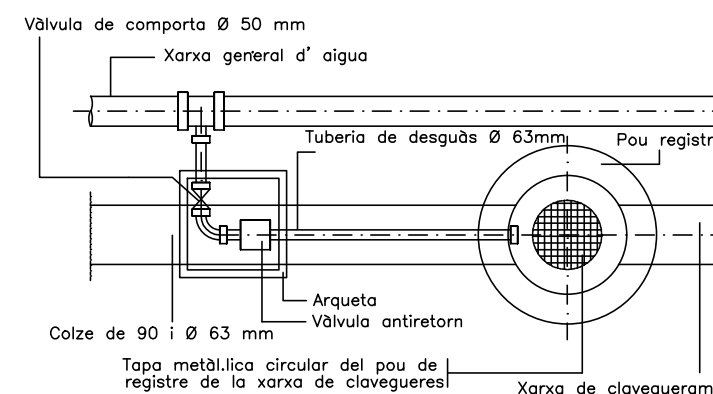
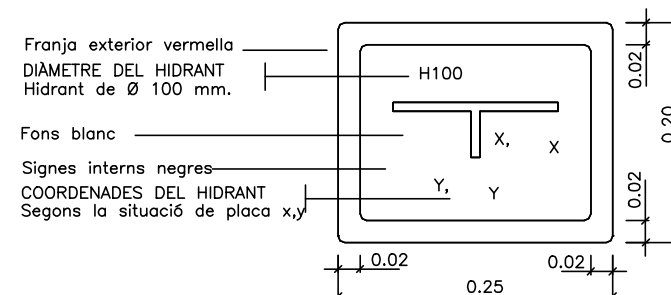
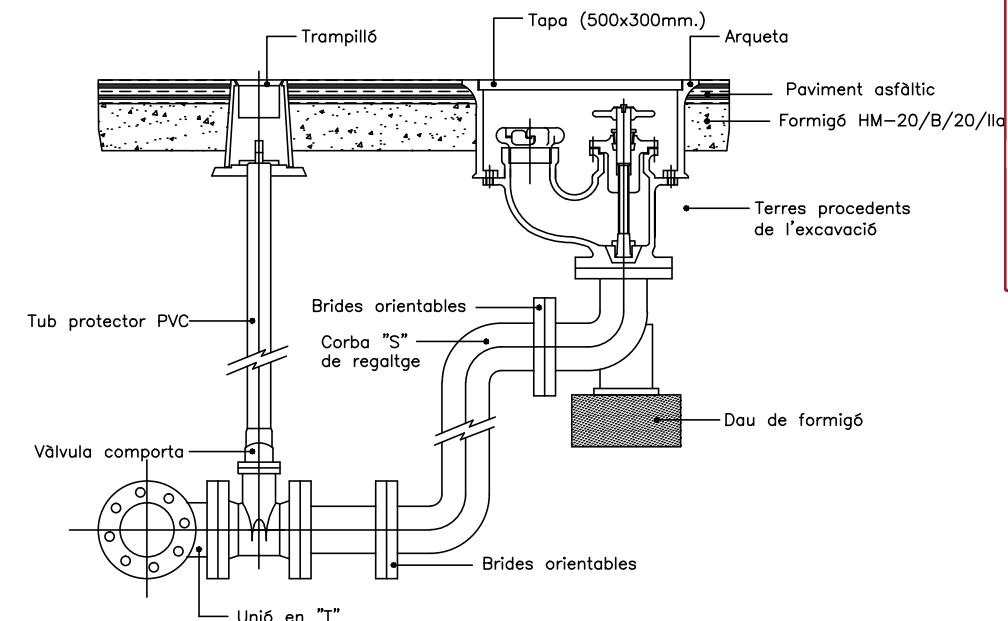

REDUCTORA DE PRESSIÓ

- a - Brida endoll Ø 125.
- b - Colze de 90° d'acer Ø 125.
- c - Con reductor de Ø 125 a Ø 100.
- d - Col·lector d'acer inoxidable Ø 100.
- e - Vàlvula de comporta Ø 100.
- f - Filtre Ø 100.
- g - Reductora Ø 100.
- h - Carret de desmuntatge Ø 100.
- i - Col·lector d'acer inoxidable Ø 80.
- j - Vàlvula de comporta Ø 80.
- l - Reductora Ø 80.
- ll - Filtre Ø 80.

ESCALA - / -